



A WATTS Brand

7B2 Series Elvari™ Surface-Mounted Shelf

Key Features

- High quality and modern style complements other [Elvari™ products](#)
- Single-piece design for easy mounting
- Advanced welding construction of front and sides
- Optional hooks for personal items, two per shelf
- Radiused sides for a softer design

Guide Specification

Top and back of surface-mounted shelf shall be fabricated of 20-gauge, 300 series stainless steel in a brushed #3 satin finish and has an integral back mounting plate. Front and sides shall be fabricated of 18-gauge, 300 series stainless steel in a brushed #3 satin finish. All exposed surfaces in architectural satin finish. Optional hooks for holding personal items are available. Hooks mount between the wall and back of shelf and are constructed of 20-gauge, 300 series stainless steel in a brushed #3 satin finish or optional electrocoat finishes.

MasterFormat Title: Commercial Toilet Accessories

MasterFormat Number: 10 28 13.13

OmniClass Title: Toilet and Bath Specialties

OmniClass Code: 23.31.25.00

Product Compliance

Listed by UL Environment to

- GreenGuard Gold



BradEX® Models

Standard Model Number	Depth (mm)	Length (mm)	Hooks (qty. 2)
7B2-0051200	5" (127)	12" (305)	No
7B2-0051800	5" (127)	18" (457)	No
7B2-0082400	8" (203)	24" (610)	No
7B2-0051296	5" (127)	12" (305)	Yes
7B2-0051896	5" (127)	18" (457)	Yes
7B2-0082496	8" (203)	24" (610)	Yes

For information on Warranties, Maintenance and BAA/ARRA Compliance, visit our website at: bradleycorp.com/washroom-accessories-products

Orders composed of products indicated as **BradEX®** will be available to ship in three days after receipt of order at the factory. There is no pricing penalty for this service from Bradley.

Verify all rough-in dimensions prior to installation.

Page 1 of 3

8/2/2024

[View Latest Version](#)

This information is subject to change without notice.

Bradley_Shelf_7B2-Series

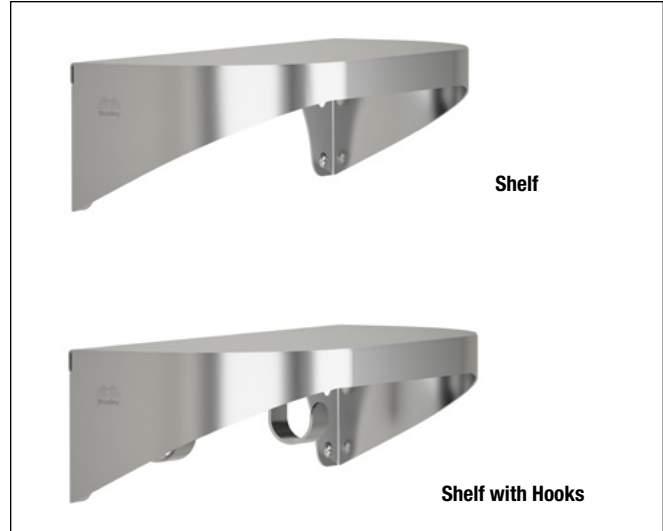

Finishes

Click on any color swatch to view as a larger image.

-  Brushed Black*
-  Brushed Brass*
-  Brushed Bronze*
-  Brushed Nickel*
-  Brushed Stainless*
-  Satin Stainless

*Electrocoat Finishes, see Optional Electrocoat Finishes on page 2.

Complementary Bradley Products

- [Euro Style Partitions – Highrise Series](#)
- [Euro Style Partitions – Skyline Series](#)
- [Euro Style Partitions – Float Series](#)
- [Euro Style Partitions – Lucent Series](#)
- [Euro Style Partitions – Loft Series](#)

© 2024 Bradley

P.O. Box 309, Menomonee Falls, WI 53052-0309
 800 BRADLEY (800 272 3539) +1 262 251 6000
bradleycorp.com









A WATTS Brand

7B2 Series Elvari™ Surface-Mounted Shelf

Optional Electrocoat Finishes

Bradley offers an exclusive, proprietary electrocoat color process on the Elvari shelf models. Unlike powder coating, color is applied to the entire stainless steel part using a submersion process with electrically charged particles. This process results in a precise film thickness across all surfaces, allowing the grain of the stainless steel to show through.

Electrocoat provides complete coverage to the part and has environmental advantages such as no or low-VOC and HAPs (Hazardous Air Pollutants), heavy metal-free products, and minimum waste discharge. Bradley's electrocoat is durable and easy to clean as well as fingerprint, stain and corrosion resistant. A UV light stabilizer additive enhances resistance to weathering and color fade. Products are performance tested for adhesion following ASTM D3359-22 and impact resistance following ASTM D2794.

Models (Must select one)	
Model	Description
7B2	Elvari Surface-Mounted Shelf
Standard Selections (Must select one from each category)	
Shelf Depth (select one)	
5	5" Deep
8	8" Deep
Shelf Length (select one)	
12	12" Long
18	18" Long
24	24" Long
Hooks (select one)	
0	No Hooks
96	Hooks (qty. 2)
Shelf Finish Type (Must select one)	
BB	 Brushed Black
BR	 Brushed Brass
BZ	 Brushed Bronze
BN	 Brushed Nickel
BS	 Brushed Stainless
SS	 Satin Stainless ¹

¹ Model available with **BradEX**® expedited shipping.

Note: Only 5" x 12", 5" x 18", and 8" x 24" shelves are available with **BradEX** shipping.

Orders composed of products indicated as **BradEX**® will be available to ship in three days after receipt of order at the factory. There is no pricing penalty for this service from Bradley.

Verify all rough-in dimensions prior to installation.



A WATTS Brand

7B2 Series Elvari™ Surface-Mounted Shelf

Dimensions

(mm)

Shelf dimensions shown with optional hooks. Dimensions for shelves without hooks similar.

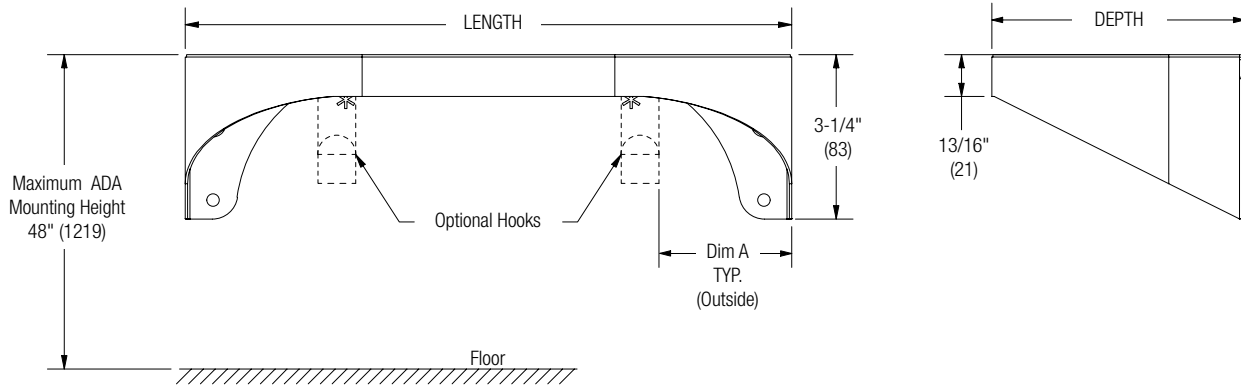

Standard Model Number	Depth (mm)	Length (mm)	Dim A (mm)	Hooks (qty. 2)
7B2-0051200	5" (127)	12" (305)	N/A	No
7B2-0051800	5" (127)	18" (457)	N/A	No
7B2-0052400	5" (127)	24" (610)	N/A	No
7B2-0081200	8" (203)	12" (305)	N/A	No
7B2-0081800	8" (203)	18" (457)	N/A	No
7B2-0082400	8" (203)	24" (610)	N/A	No
7B2-0051296	5" (127)	12" (305)	2.63" (66.80)	Yes
7B2-0051896	5" (127)	18" (457)	2.63" (66.80)	Yes
7B2-0052496	5" (127)	24" (610)	2.53" (143.00)	Yes
7B2-0081296	8" (203)	12" (305)	2.63" (66.80)	Yes
7B2-0081896	8" (203)	18" (457)	2.63" (66.80)	Yes
7B2-0082496	8" (203)	24" (610)	2.53" (143.00)	Yes

Orders composed of products indicated as **BradEX**® will be available to ship in three days after receipt of order at the factory. There is no pricing penalty for this service from Bradley.

Verify all rough-in dimensions prior to installation.

Page 3 of 3

8/2/2024

[View Latest Version](#)

This information is subject to change without notice.

Bradley_Shelf_7B2-Series

© 2024 Bradley

P.O. Box 309, Menomonee Falls, WI 53052-0309

800 BRADLEY (800 272 3539) +1 262 251 6000

bradleycorp.com